

D 92x210 1pcs
D 82x205 3pcs
W 110x100 5pcs
W 60x60 1pcs

Code	MS-27.0 S-327 SR-109.3	Page	22.11.16
Drawing	9,4x8,5/2x44	Scale	
File	Astrana_2x44 3D.0		

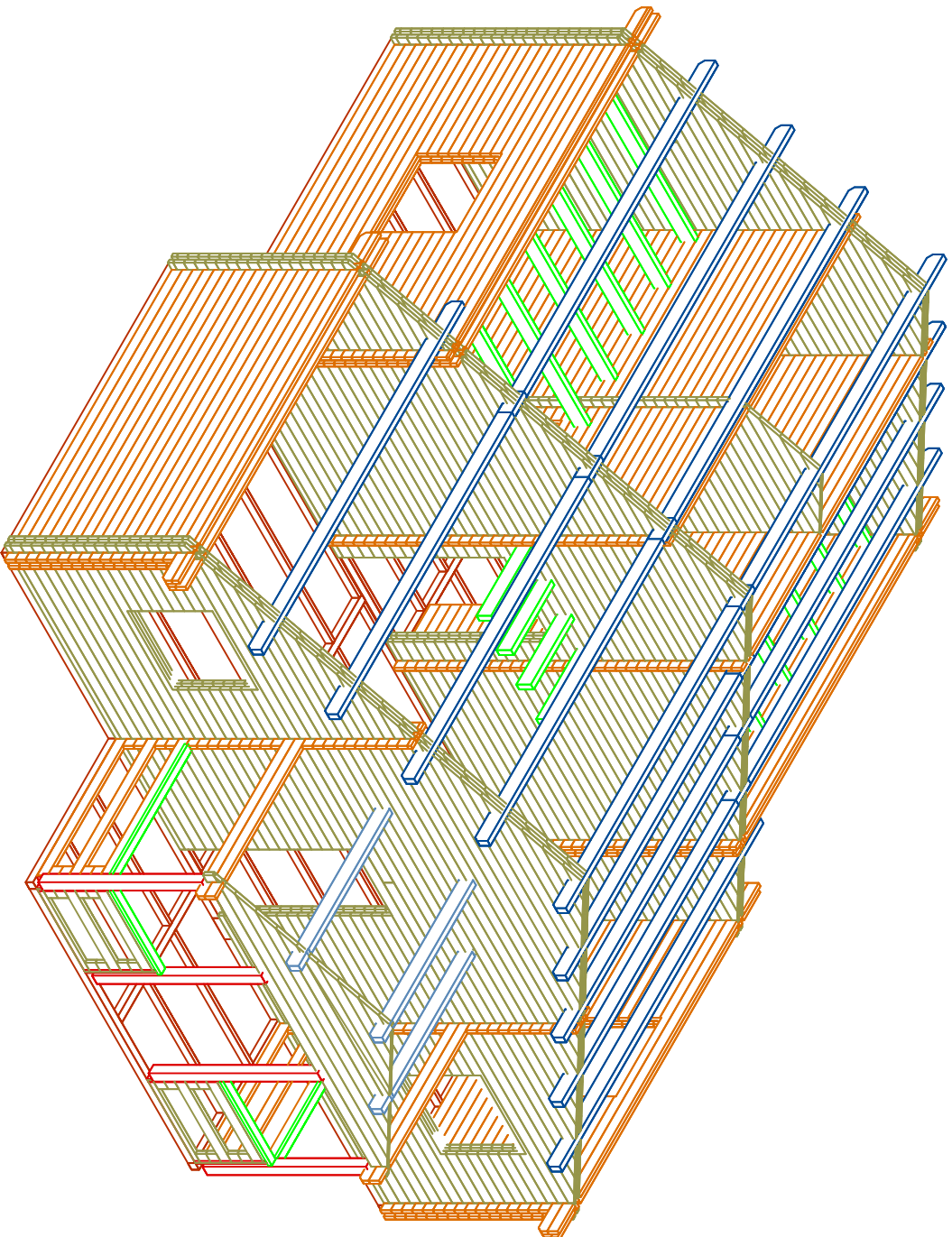

D 92x210 1pcs
D 82x205 3pcs
W 110x100 5pcs
W 60x60 1pcs

Code	MS-27.0 S-327 SR-109.3	Page	22.11.16
Drawing	9,4x8,5/2x44	Scale	
File	Ast_rana_2x44_3D.0		

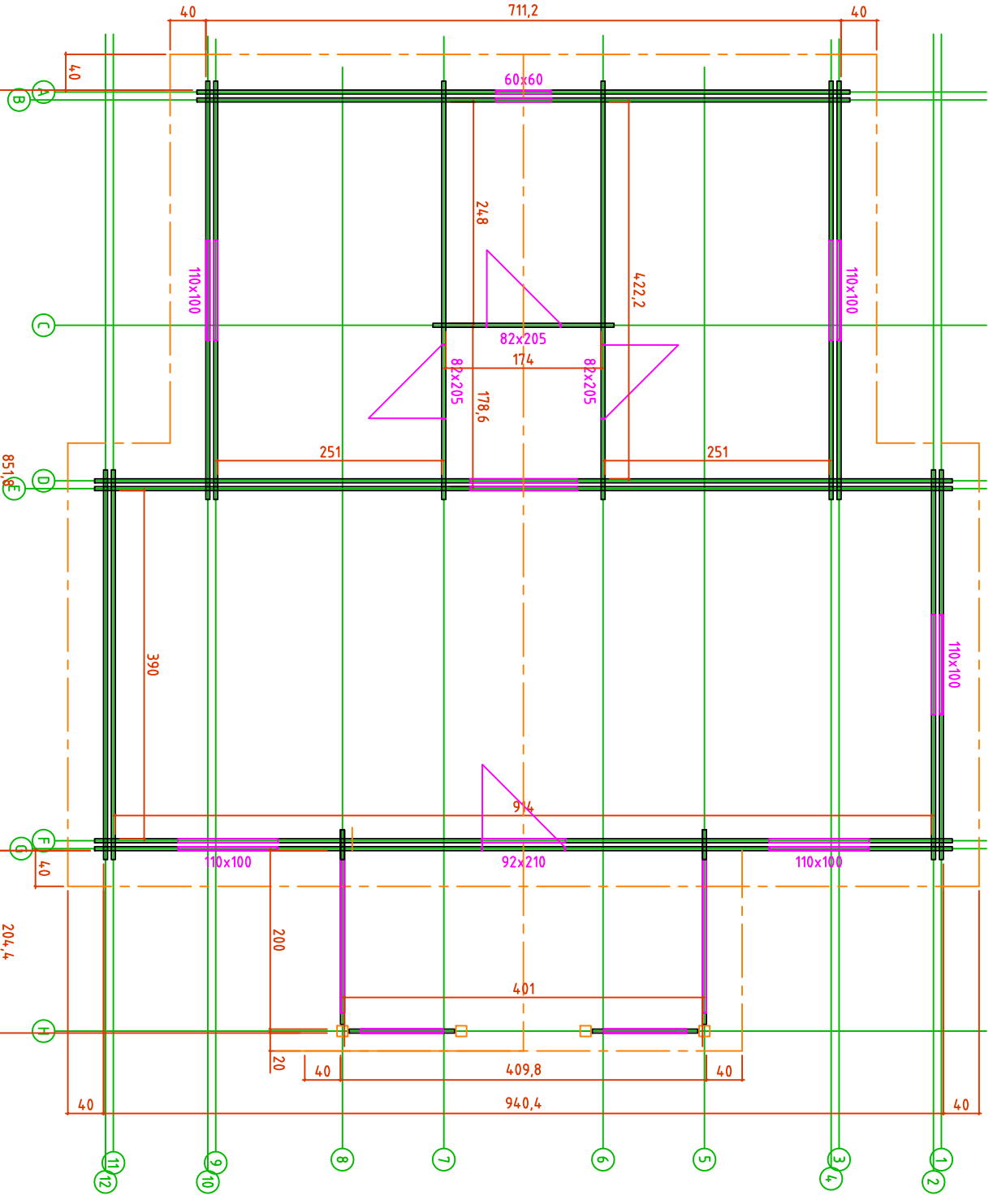

- D 92x210 1pcs
- D 82x205 3pcs
- W 110x100 5pcs
- W 60x60 1pcs

Code	Page 1	22.11.16
Drawing 9,4x8,5/2x44	Scale 1:50	
File Astra_n_2x44.dwg		

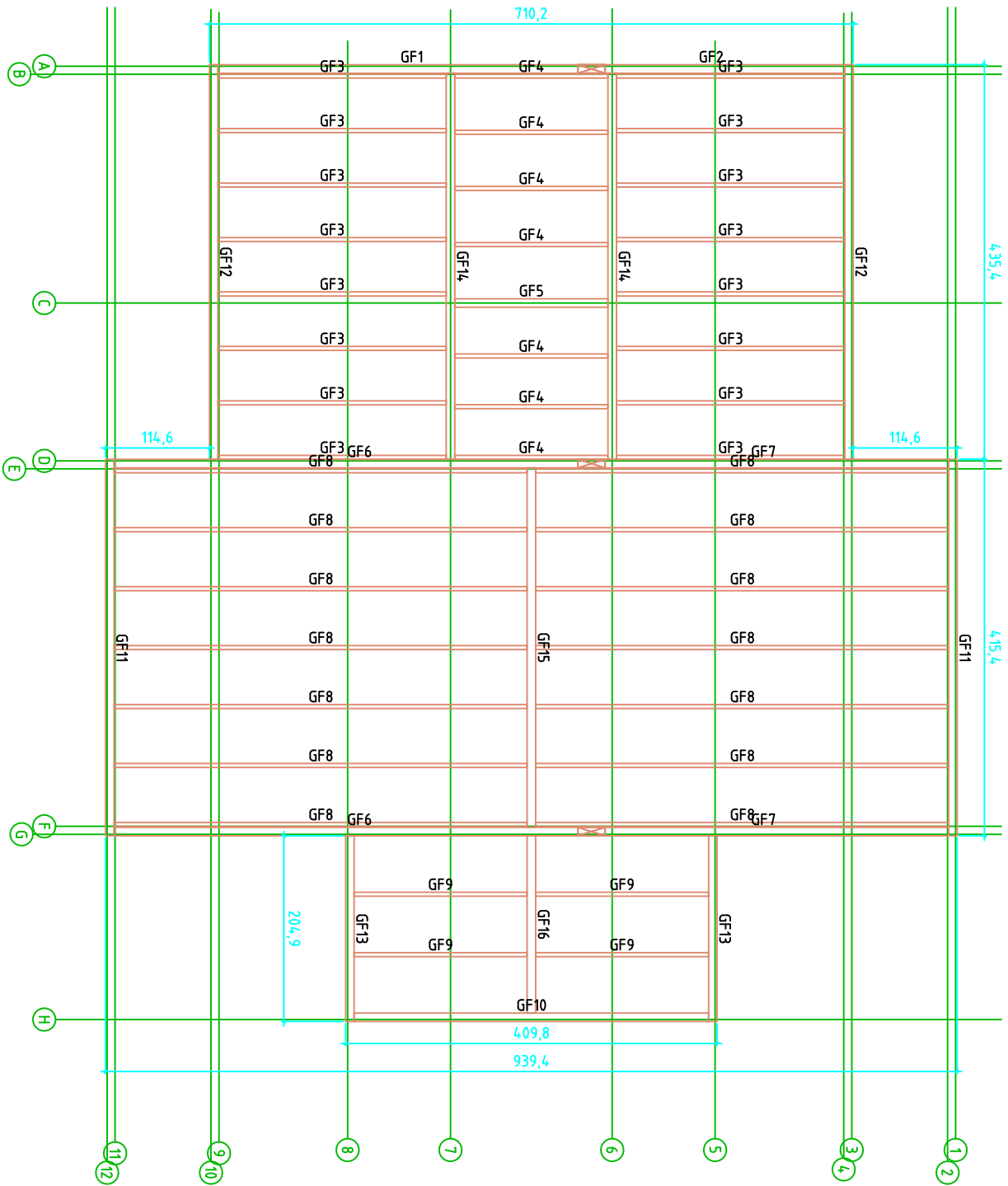

Code GROUND FRAME

Page 1a

Scale 22.11.16

Drawing 9.40x/2x44

Scale 1:50

File Astraana_2x44.dwg

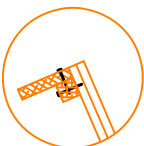

Wall A ↗

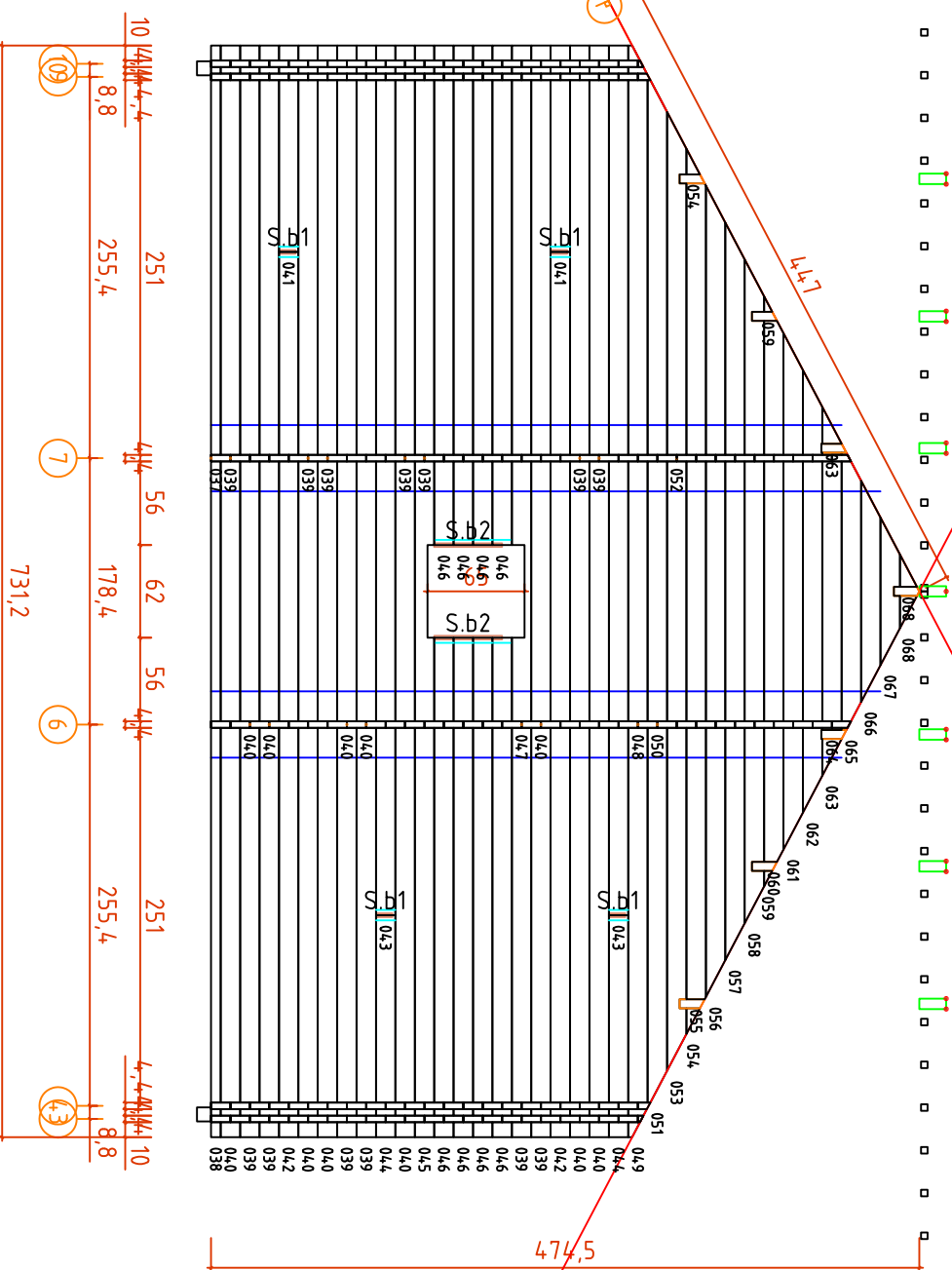

Code	Page 2	22.11.16
Drawing WALL A	Scale 1:50	
File ASTrona_2x44.dwg		

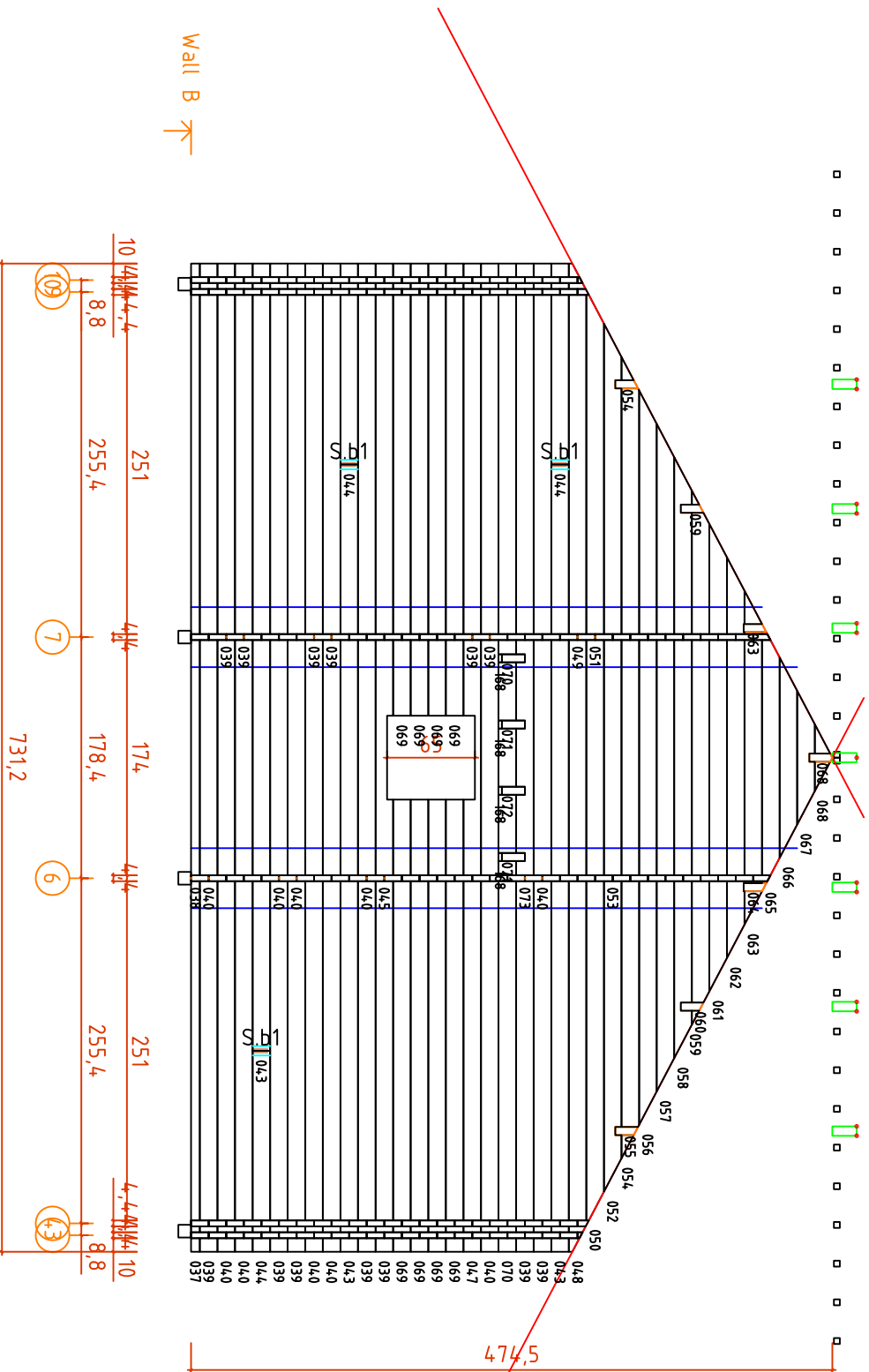

Code	Page 3	22.11.16
Drawing WALL B	Scale 1:50	
File ASTrono_2x44.dwg		

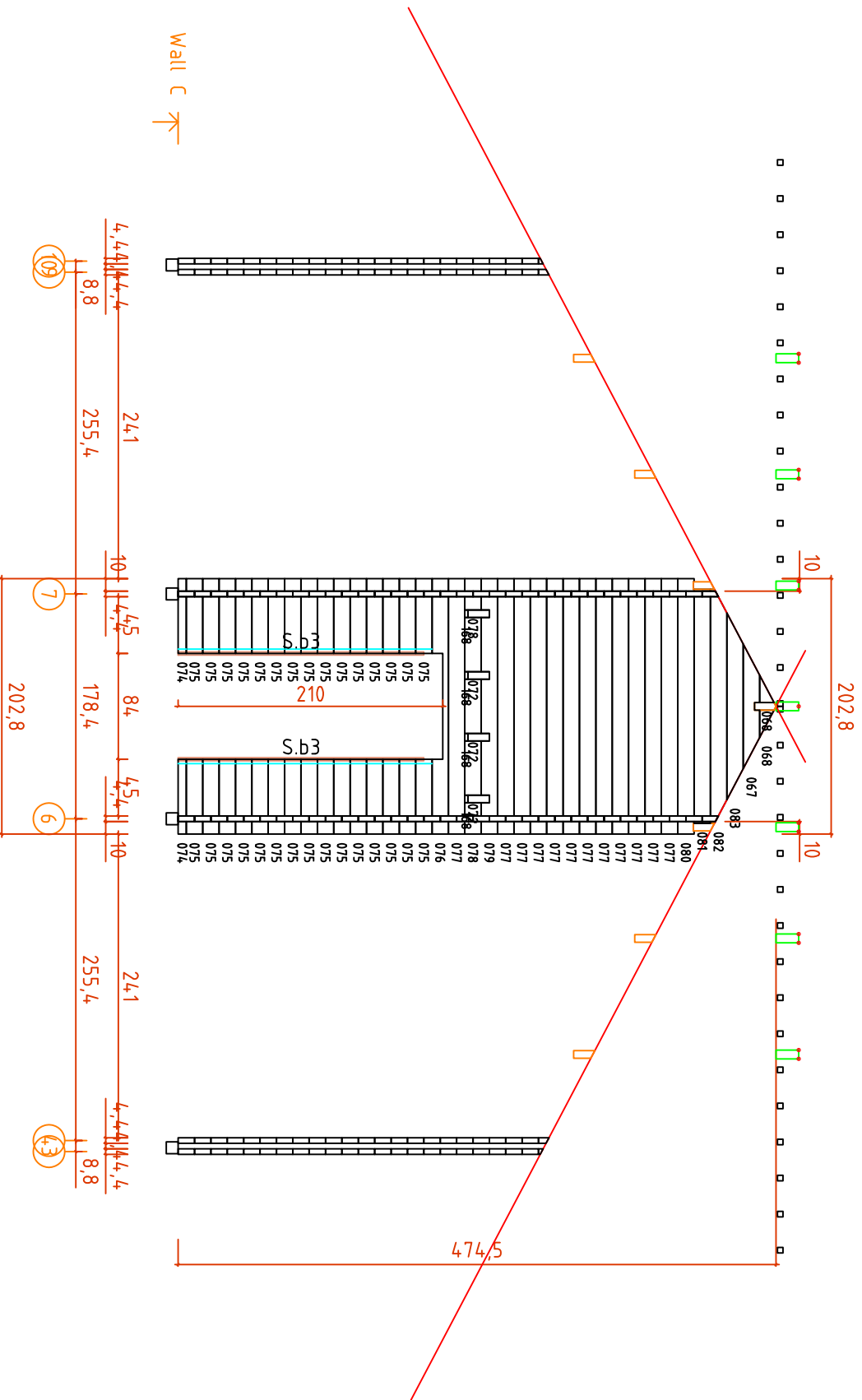

Code	Page 4	22.11.16
Drawing WALL C	Scale 1:50	
File ASTrono_2x44.dwg		

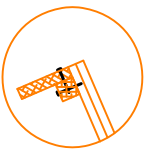

Wall D

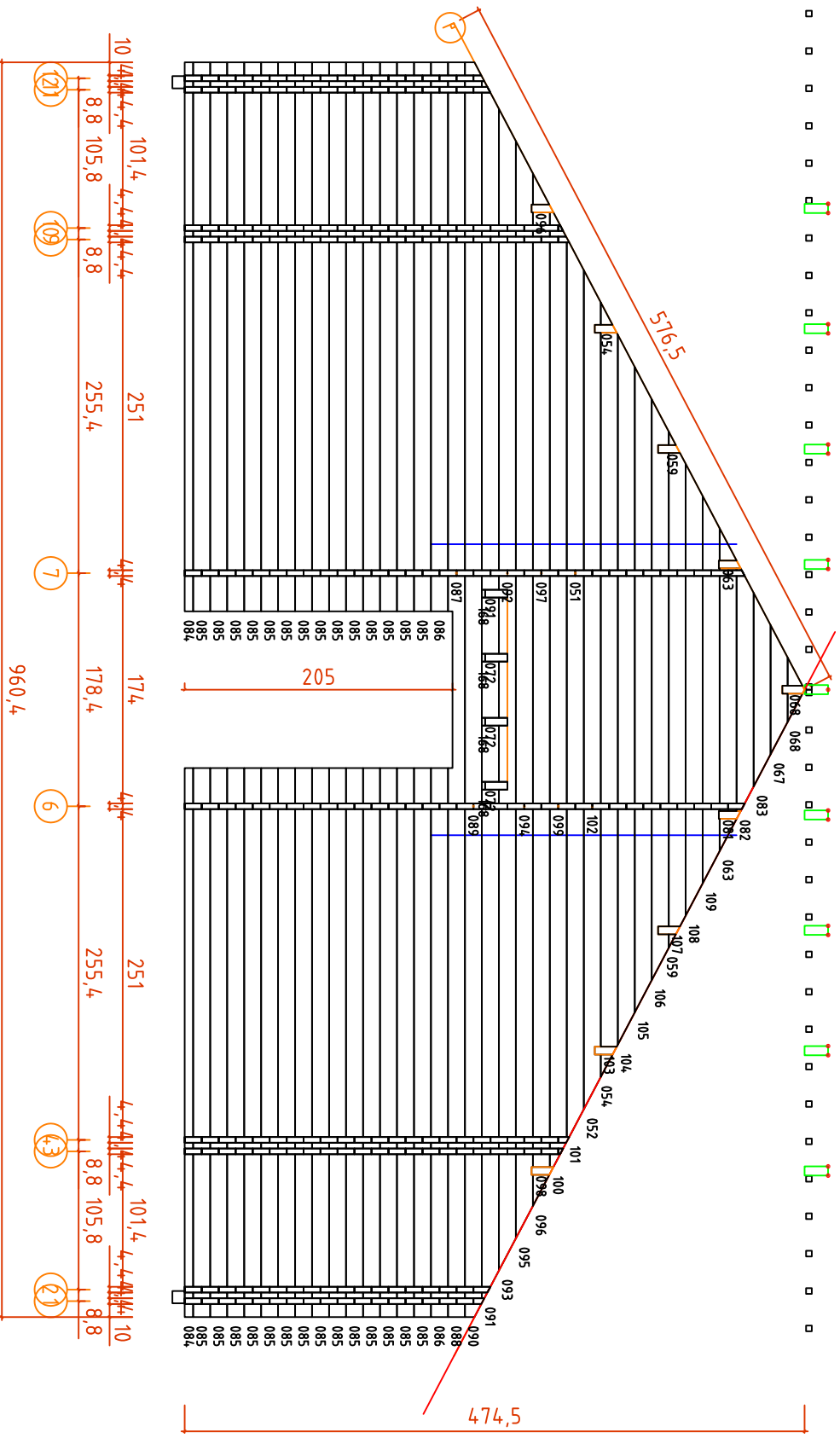

Code	Page 5	22.11.16
Drawing WALL D	Scale 1:50	
File ASTRANA_2x44.dwg		

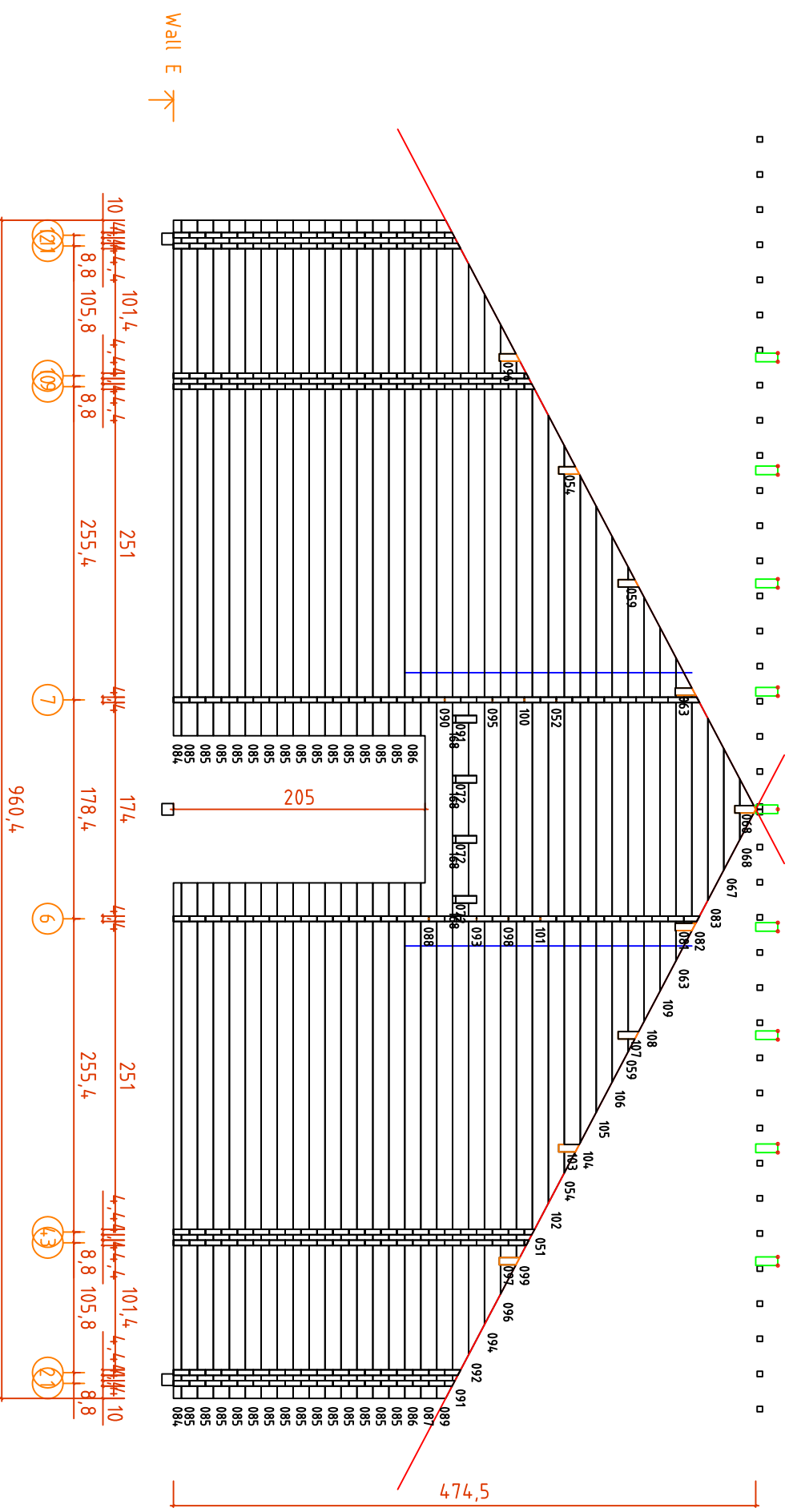

Wall E →

Code	Page 6	22.11.16
Drawing WALL E	Scale 1:50	
File ASTRANA_2x44.dwg		

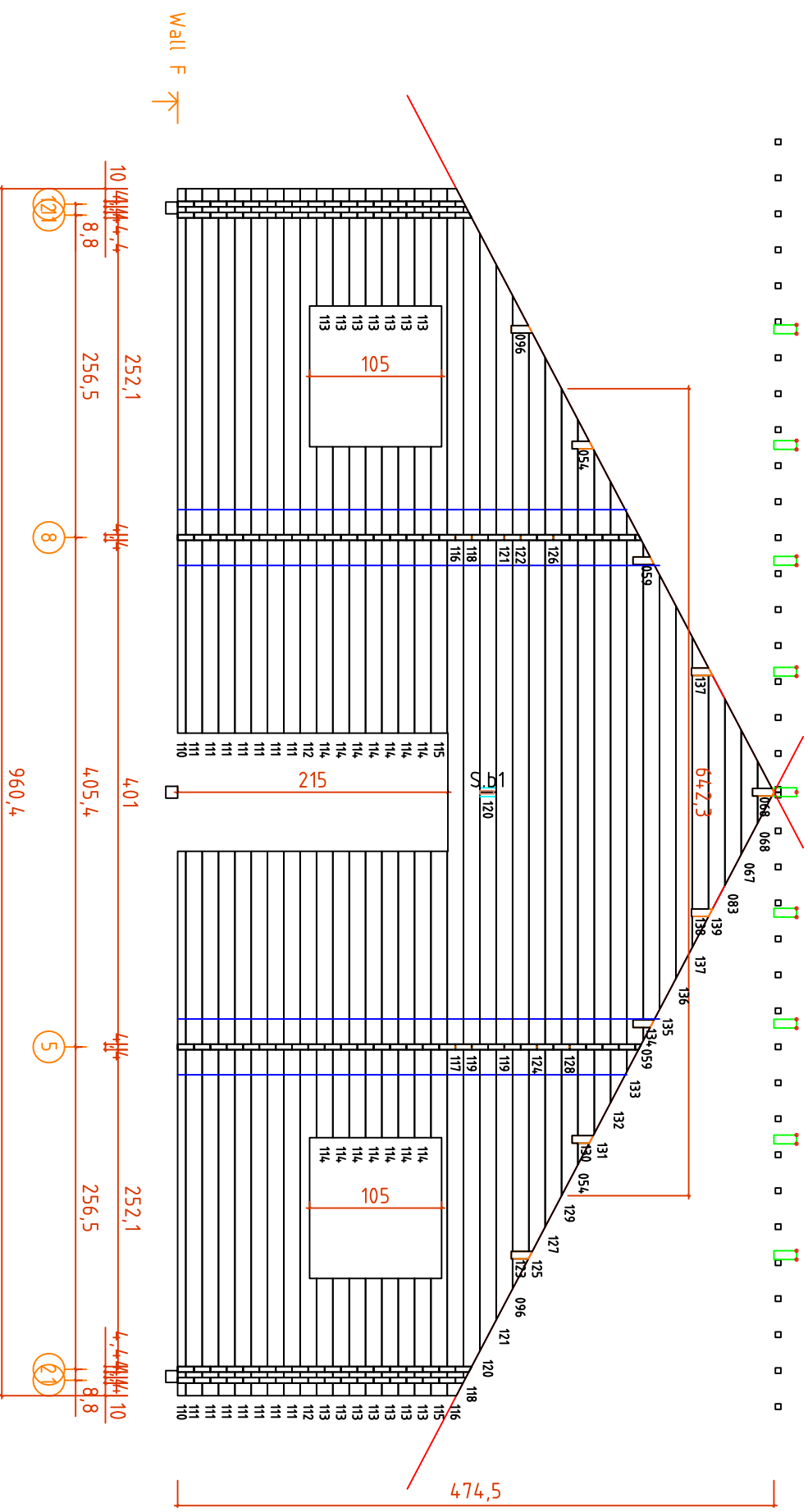

Code	Page 7	22.11.16
Drawing WALL F	Scale 1:50	
File ASTRANA_2x44.dwg		

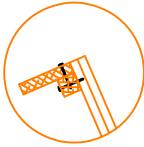

Wall H

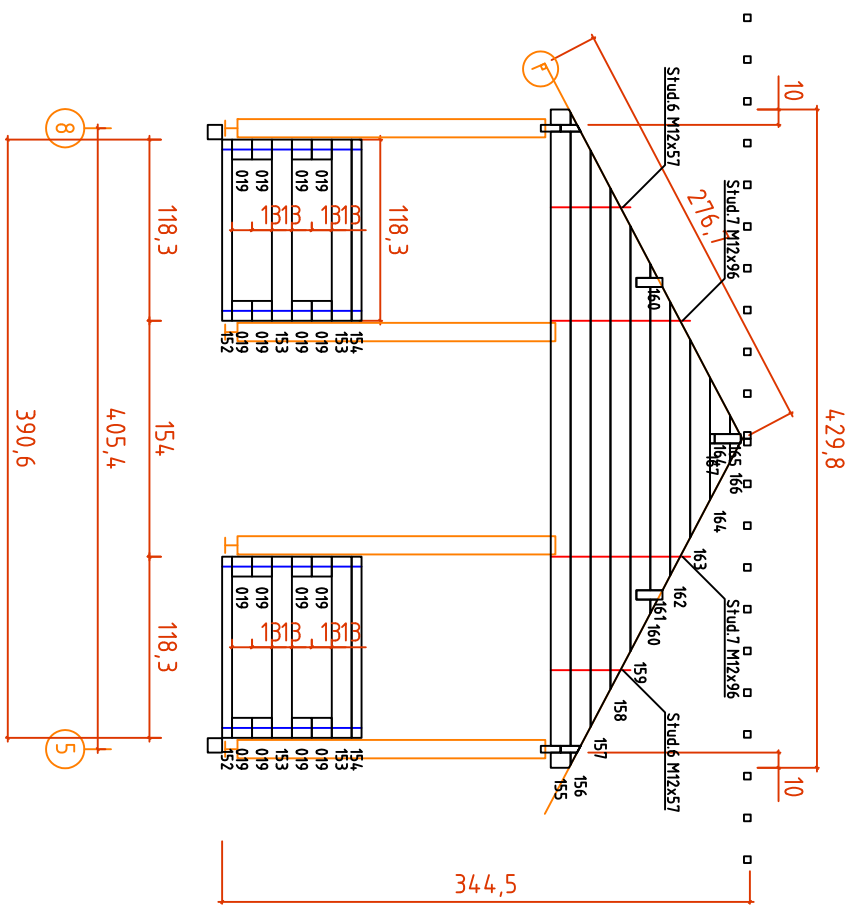

Code	Page 9	22.11.16
Drawing WALL H	Scale 1:50	
File ASTrana_2x44.dwg		

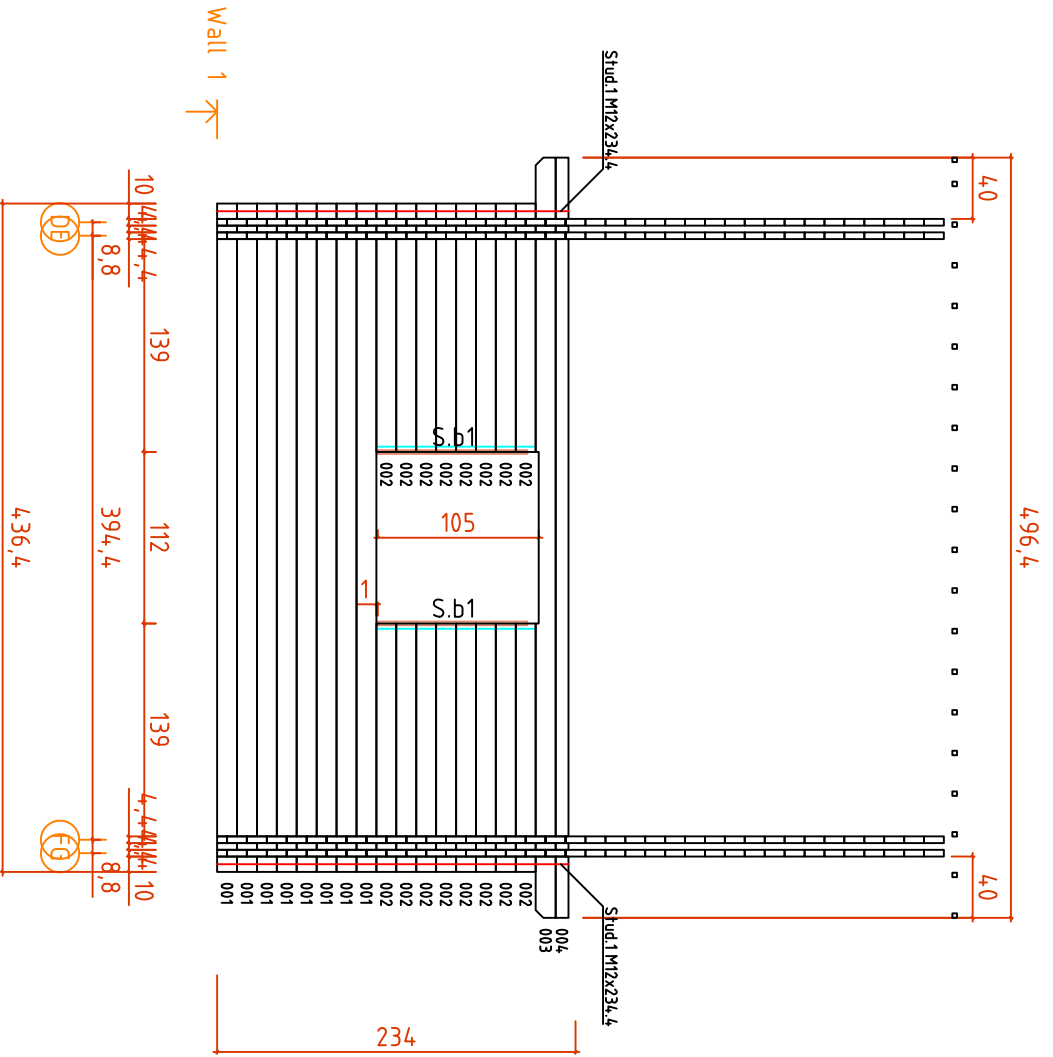

Code	Page 10	22.11.16
Drawing WALL 1	Scale 1:50	
File ASTRANO_2x44.dwg		

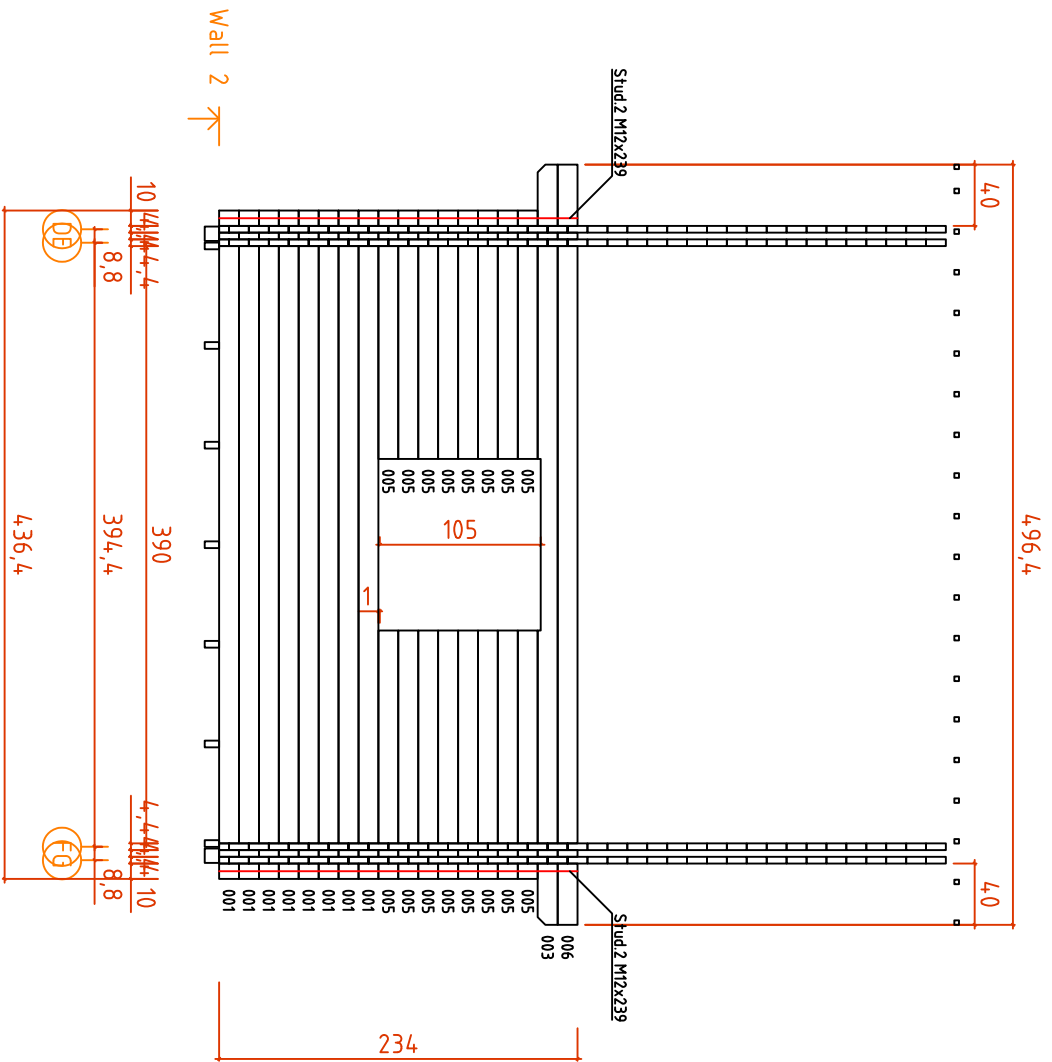

Code	Page 11	22.11.16
Drawing WALL 2	Scale 1:50	
File ASTRANO_2x44.dwg		

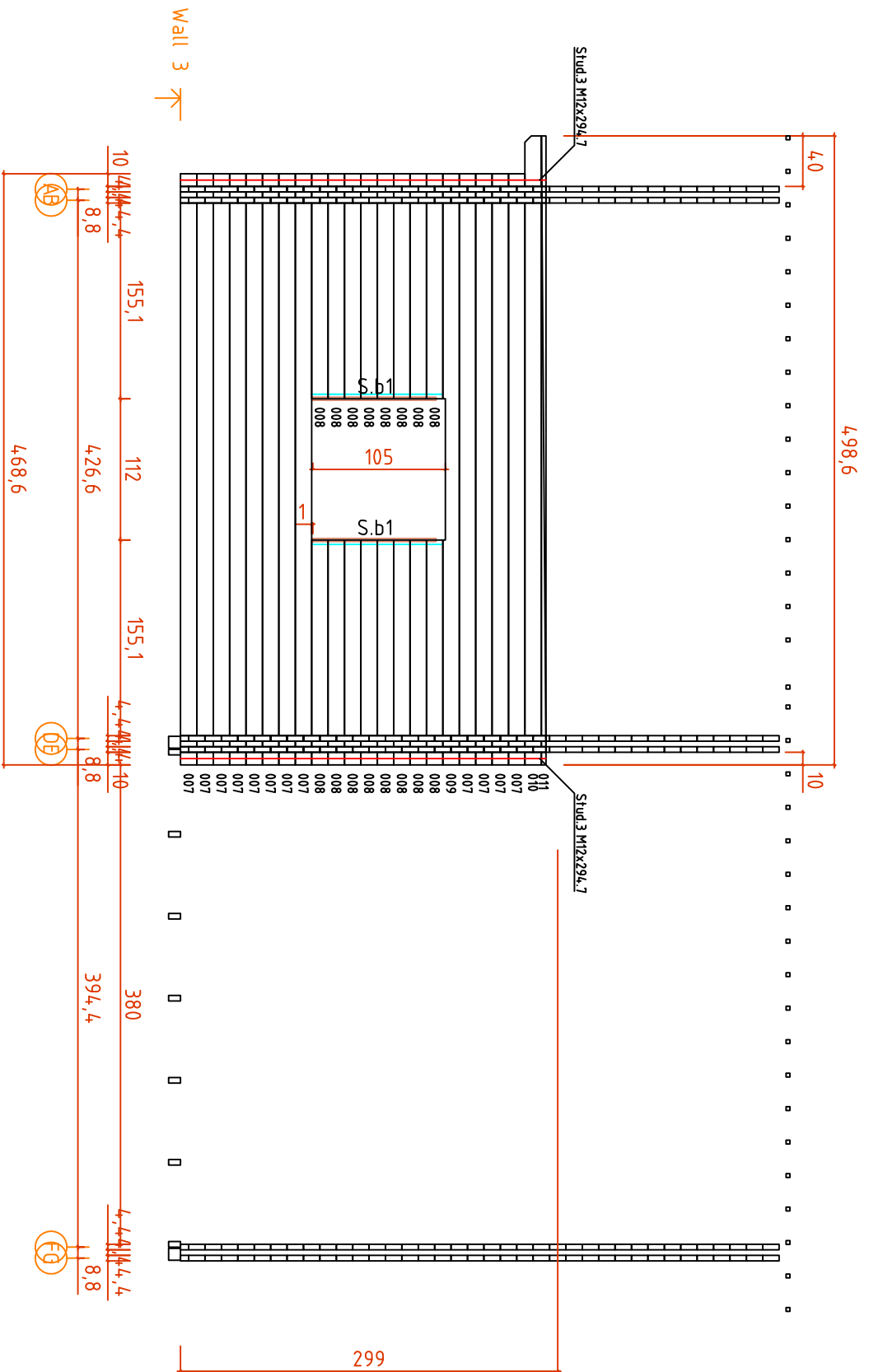

Code	Page 12	22.11.16
Drawing WALL 3	Scale 1:50	
File ASTRANO_2x44.dwg		

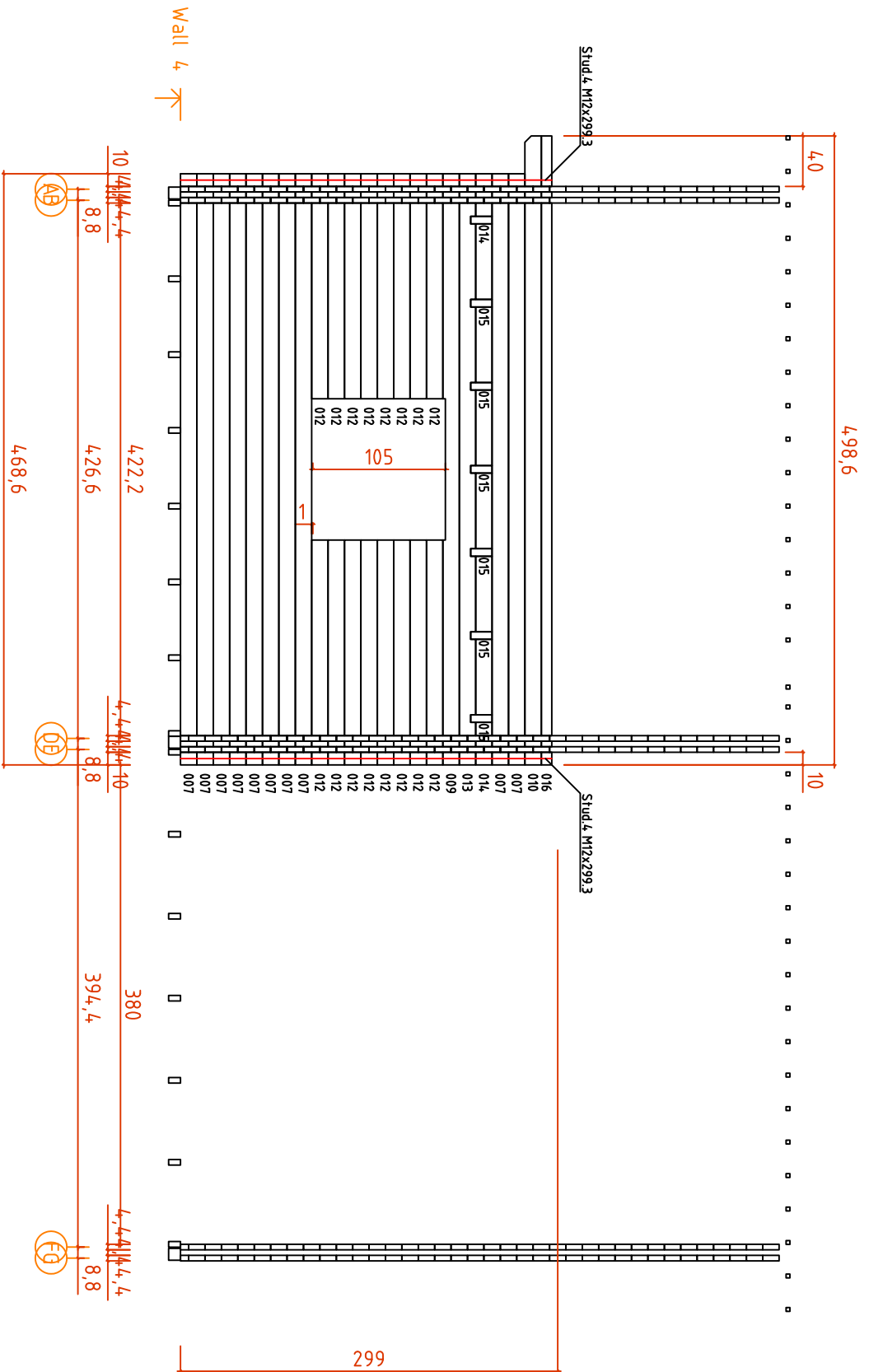

Code	Page 13	22.11.16
Drawing WALL 4	Scale 1:50	
File ASTRANO_2x44.dwg		

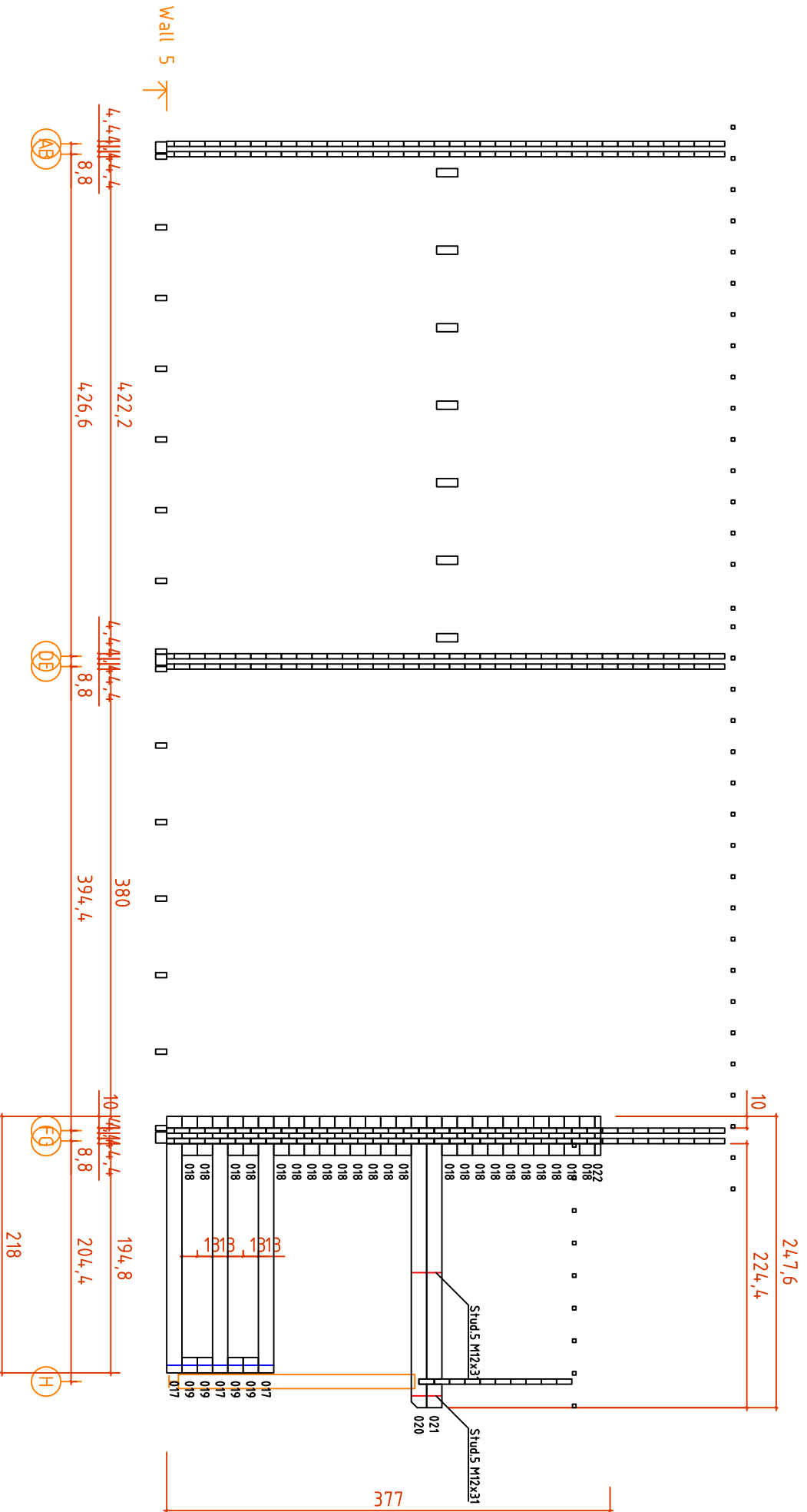

Code	Page 14	22.11.16
Drawing WALL 5	Scale 1:50	
File ASTrona_2x44.dwg		

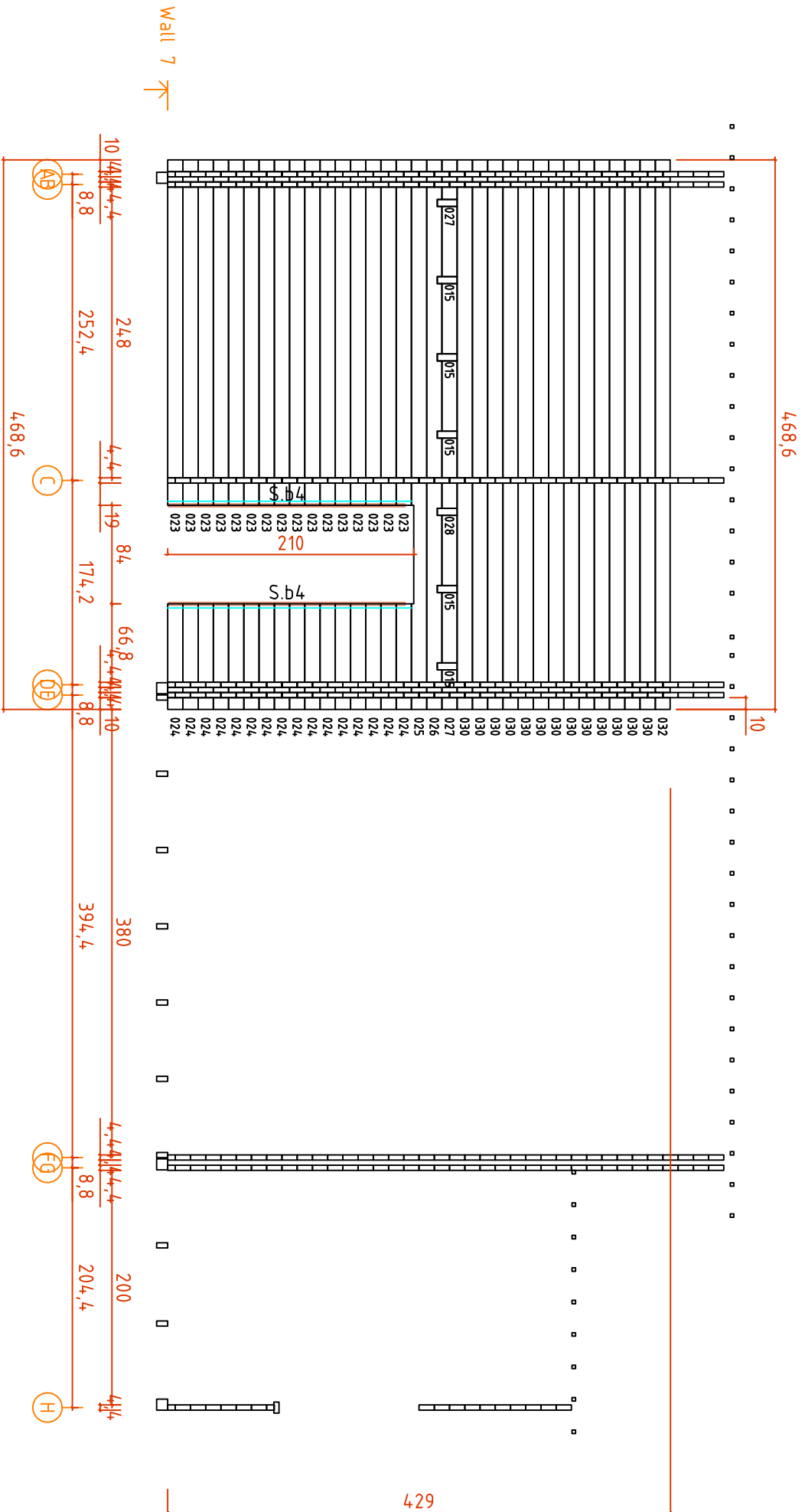

Code	Page 16	22.11.16
Drawing WALL 7	Scale 1:50	
File ASTrona_2x44.dwg		

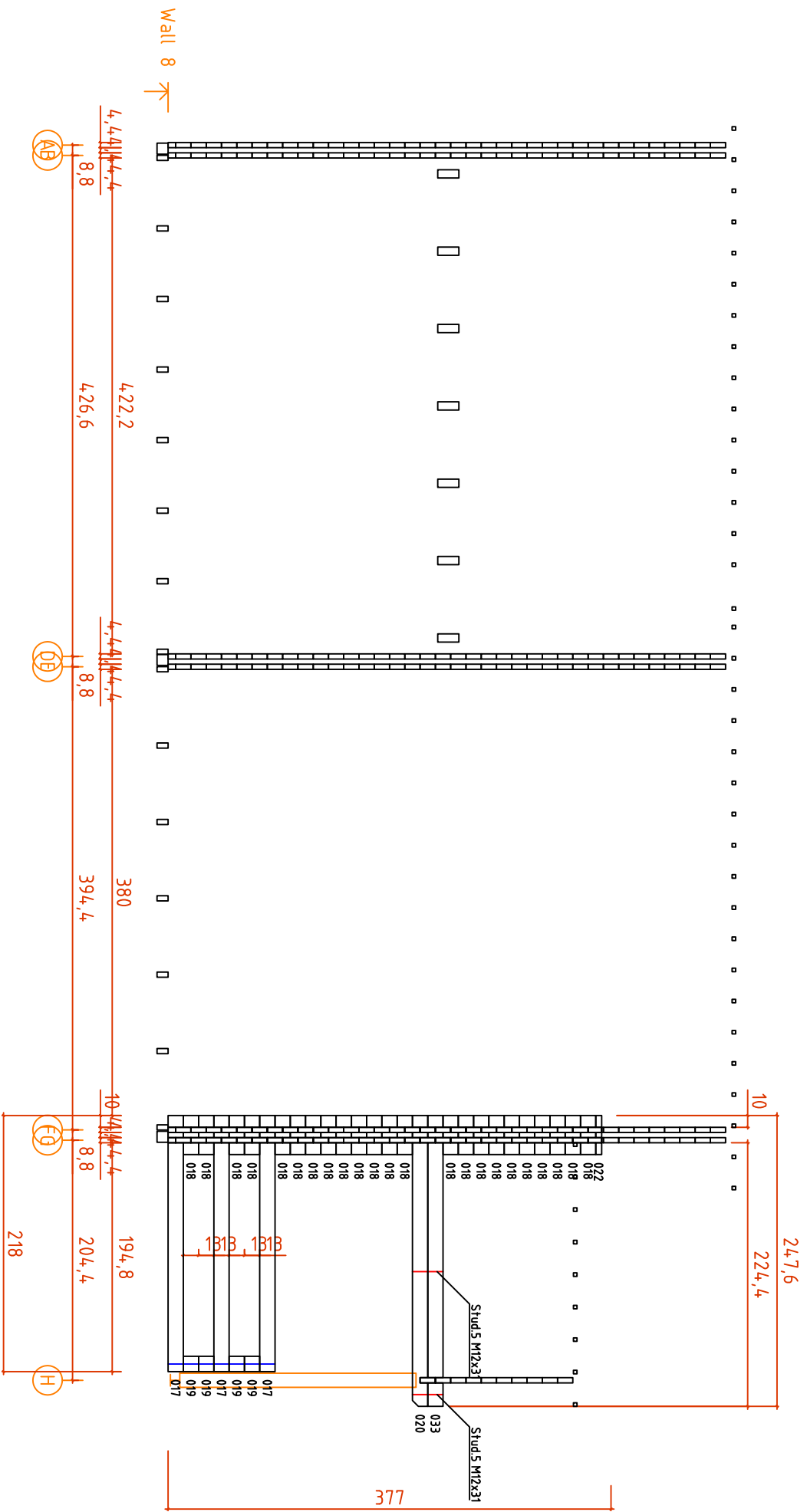

Code	Page 17	22.11.16
Drawing WALL 8	Scale 1:50	
File ASTrana_2x44.dwg		

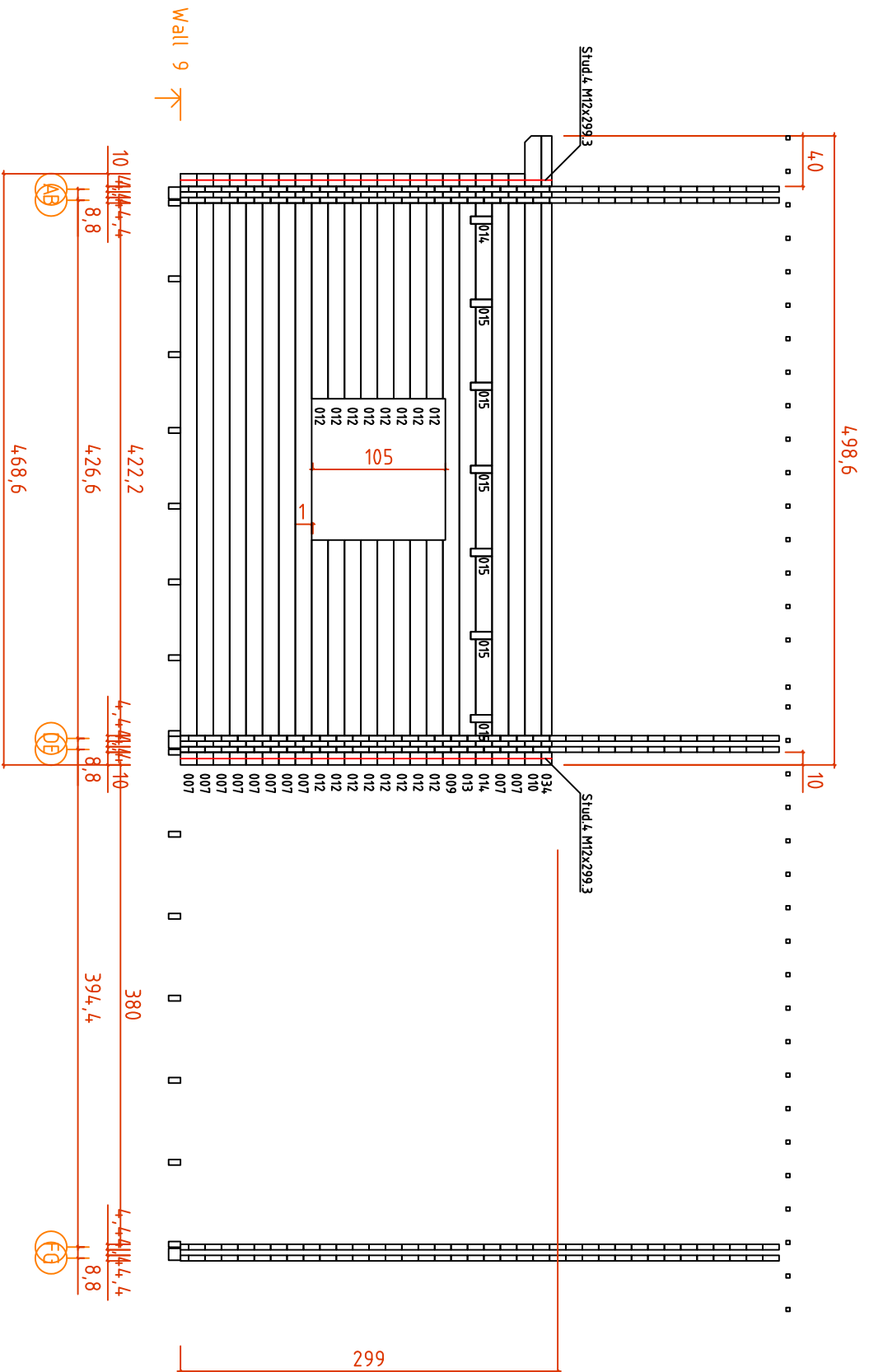

Code	Page 18	22.11.16
Drawing WALL 9	Scale 1:50	
File ASTrono_2x44.dwg		

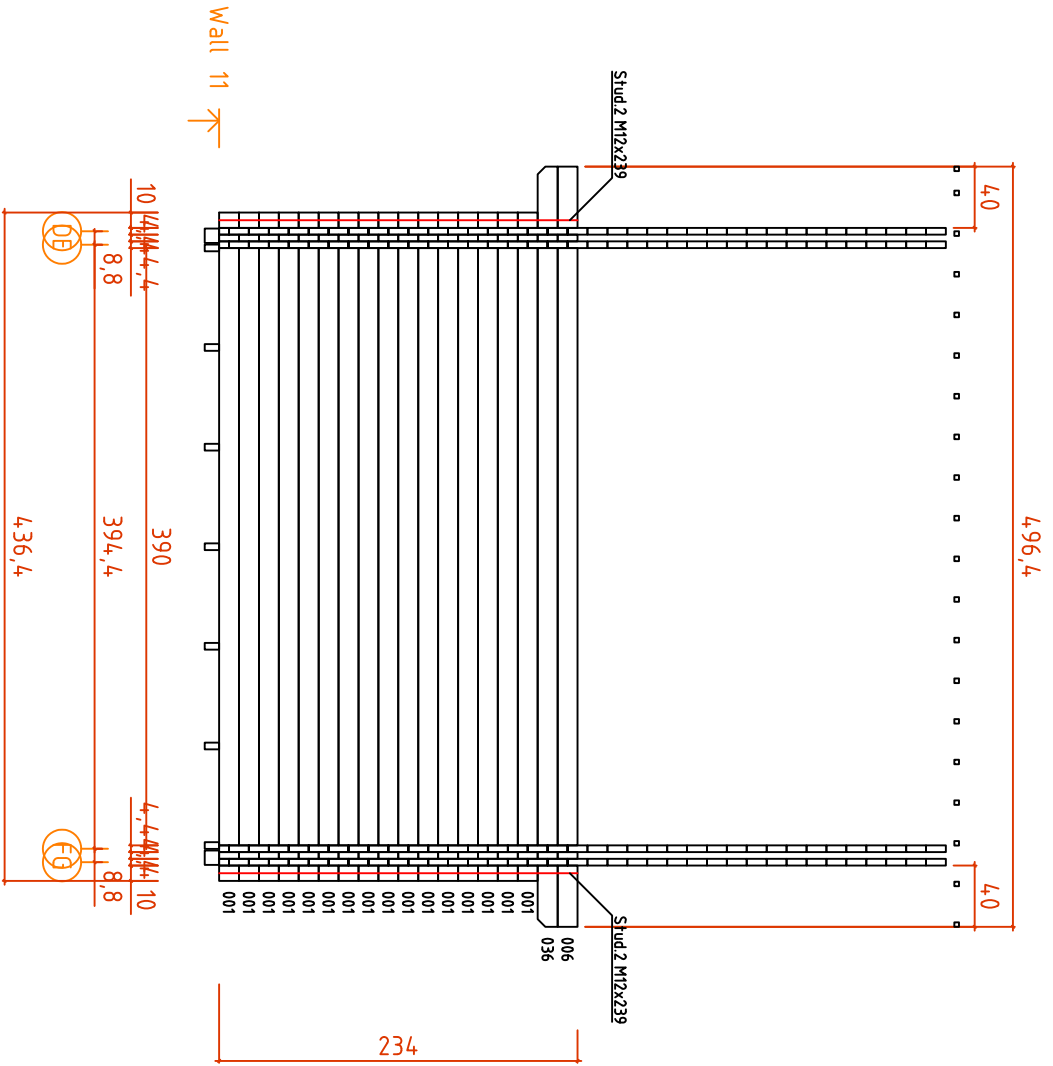

Code	Page 20	22.11.16
Drawing WALL 11	Scale 1:50	
File ASTRANO_2x44.dwg		

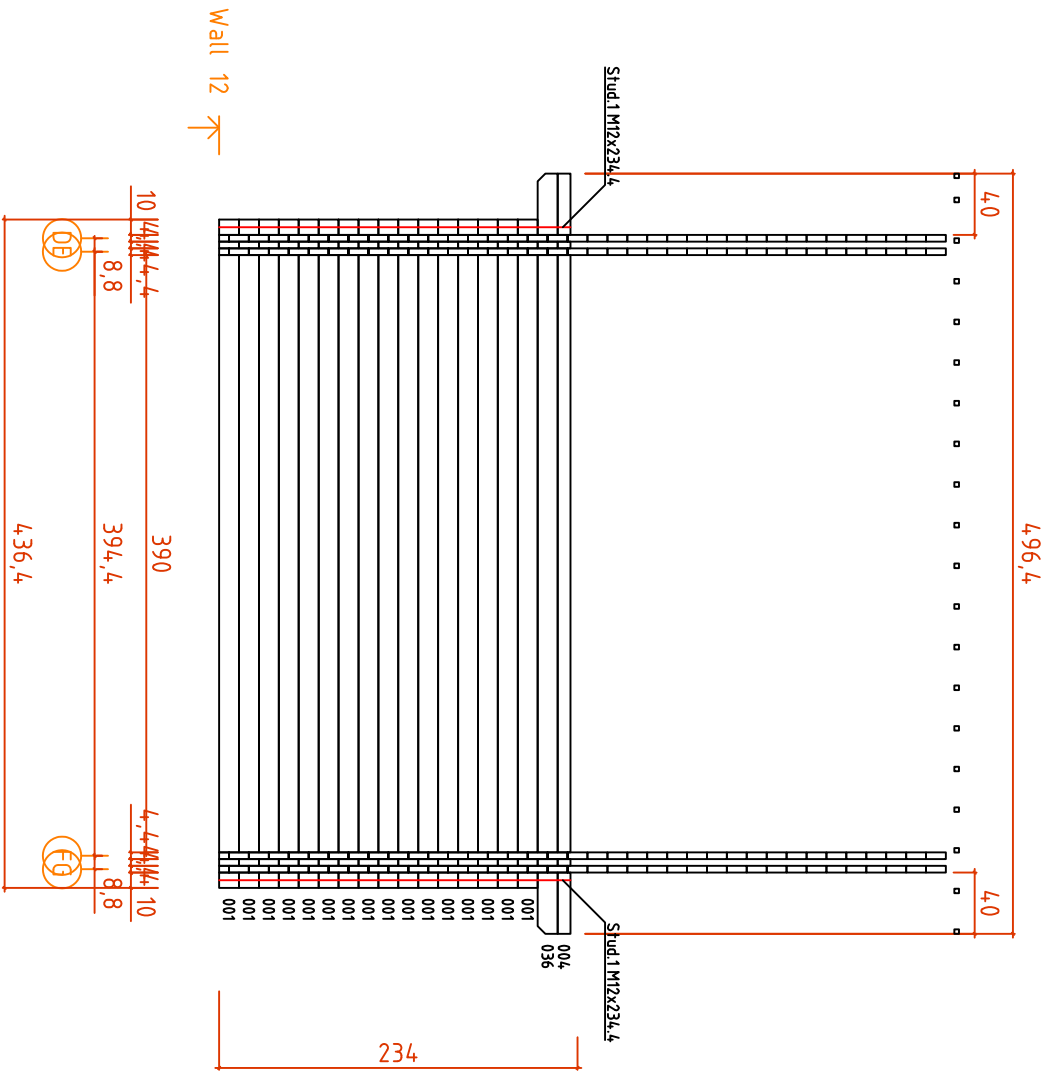

Code	Page 21	22.11.16
Drawing WALL 12	Scale 1:50	
File ASTrono_2x44.dwg		

POSITION	PROFIL, DIMENSION	
GROUND FRAMES	94x94, 44x94	
WALL	2x44	
PURLIN	70x180	
RAFTERS		
ROOF BATTENS	30x30,44x44	
ROOF BOARDS	18	
CEILING		
FLOORING	28	
TERACCE	28	

CONSTRUCTION

ROOF ANGLE	27.8°	
WALL INSULATION	44	
ROOF INSULATION		
FLOOR INSULATION		

WINDOWS,DOORS

Code	Page	
Drawing	Scale	
	File	